

**THERMALRIGHT**  
Low Temperature High Performance

## 安装说明

### Assassin X 120 REFINED SE 系列

www.thermalright.com

V1.0

### 配件清单

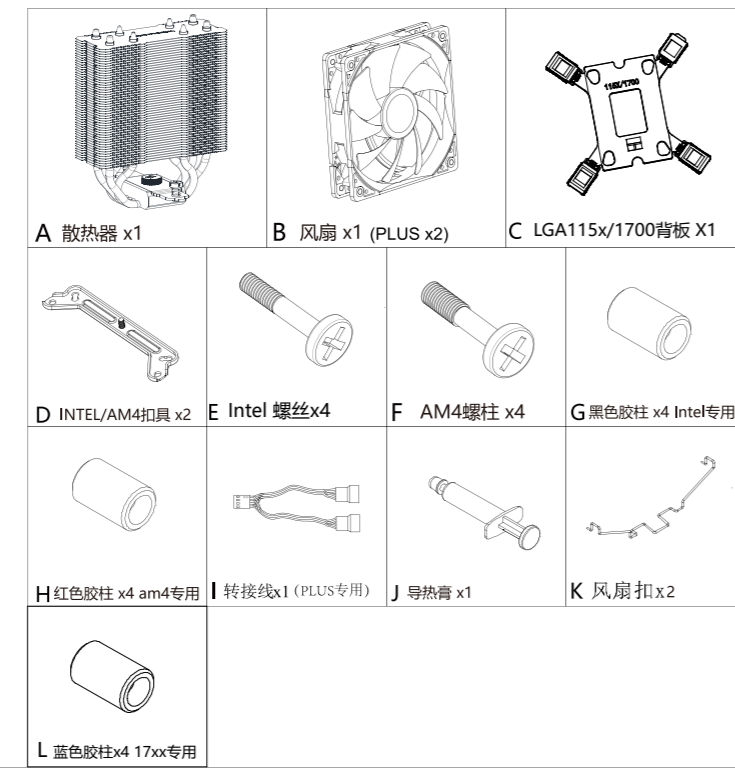

### AMD AM4

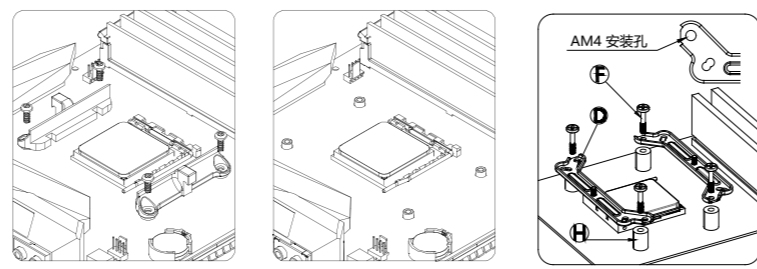

移除AMD原装塑胶支架, 保留背板; 使用AM4螺丝将AMD支架固定到背板

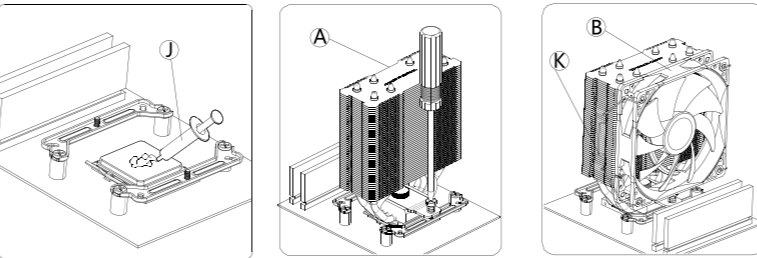

涂好导热膏, 然后先锁好散热器, 再固定风扇

### INTEL LGA115X/1200

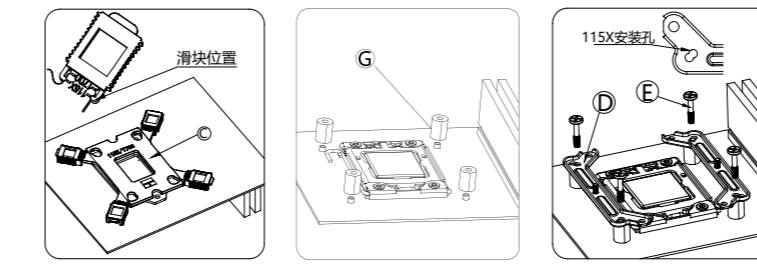

将LGA115X/1700背板放置在主板背面, 然后从正面放置胶柱. 支架再用螺丝固定住INTEL支架.

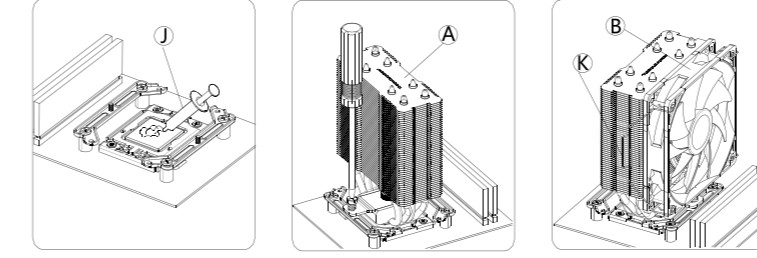

涂好导热膏, 然后先锁好散热器, 再固定风扇

### INTEL LGA1700

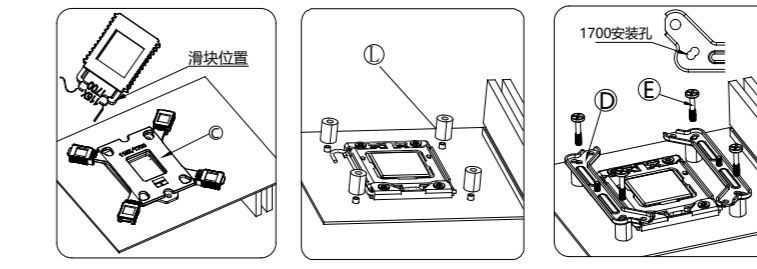

将LGA115X/1700背板放置在主板背面, 然后从正面放置胶柱. 支架再用螺丝固定住INTEL支架.

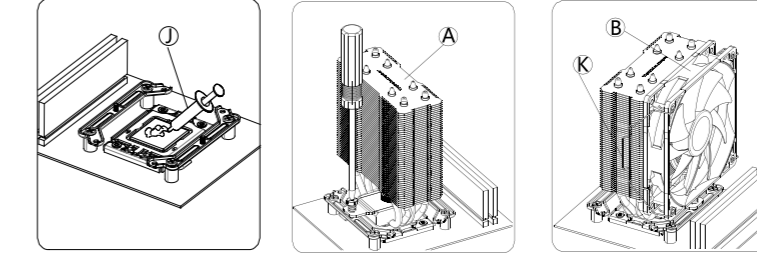

涂好导热膏, 然后先锁好散热器, 再固定风扇

### 风扇接线

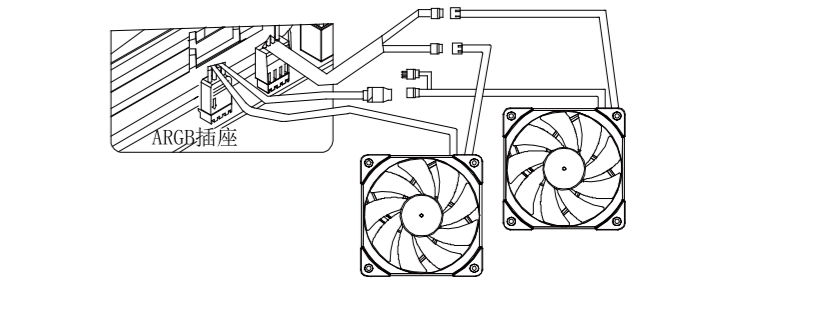
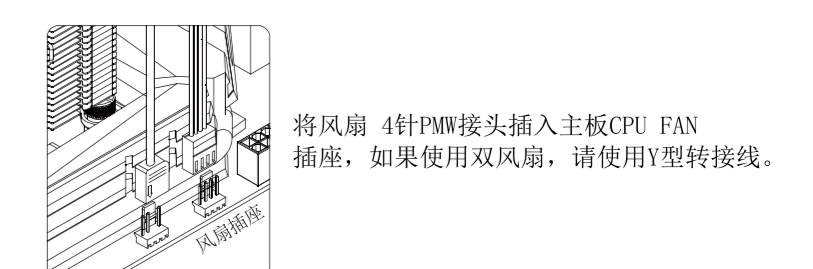

**THERMALRIGHT**  
Low Temperature High Performance

## INSTALLATION GUIDE

### Assassin X 120 REFINED SE Series

www.thermalright.com

V1.0

### parts list

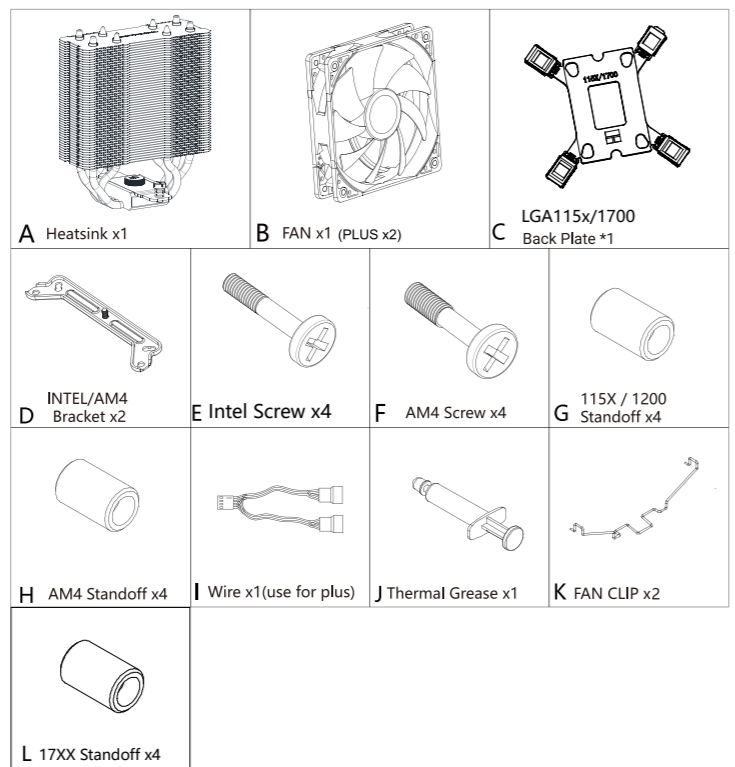

### AMD AM4

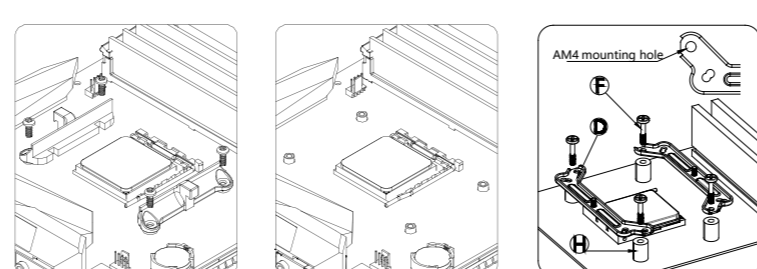

REMOVE AMD AM4 plastic brackets, KEEP the back plate, install AM4 metal brackets with AM4 screws and AM4 plastic standoffs

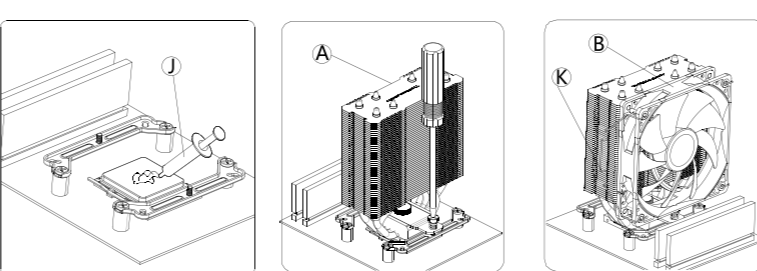

Apply thermal grease on CPU, install the heatsink with a screw driver, and install fans on heatsink with fan clips

### INTEL LGA115X/1200

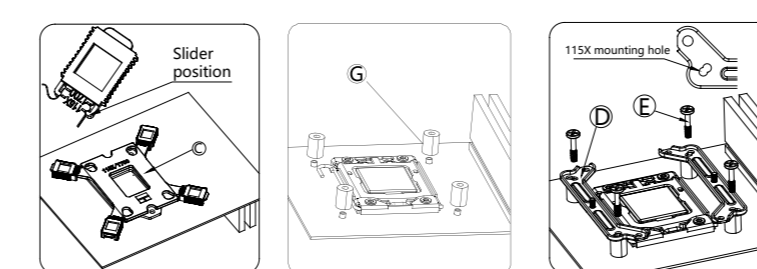

Install the LGA115X/1700 back plate from the back of motherboard, then place plastic standoffs from front side of motherboard, install LGA115X/1200 metal brackets with screws

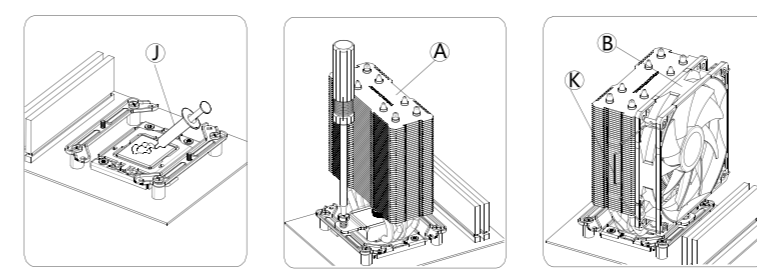

Apply thermal grease on CPU, install the heatsink with a screw driver, and install fans on heatsink with fan clips

### INTEL LGA1700

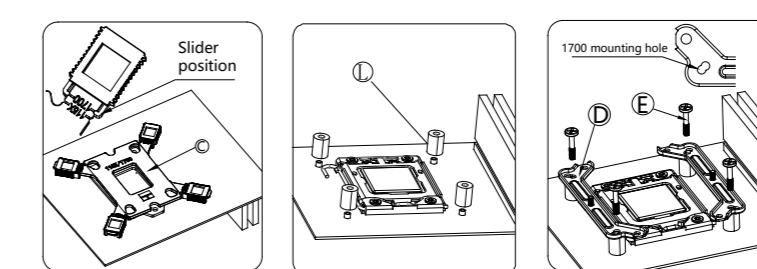

Install the LGA115X/1700 back plate from the back of motherboard, then place plastic standoffs from front side of motherboard, install LGA1700 metal brackets with screws

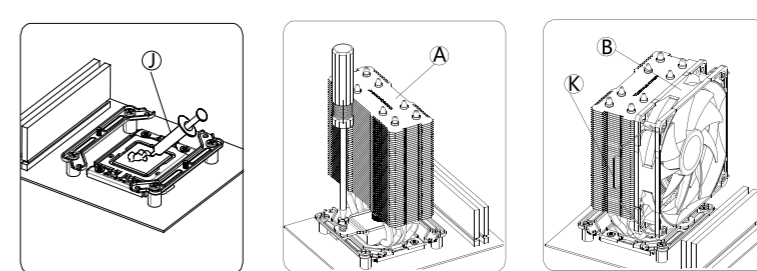

Apply thermal grease on CPU, install the heatsink with a screw driver, and install fans on heatsink with fan clips

### Fan Wiring

